









Smart Membrane Solutions







## 2018 Parts List

3.8" RO Membrane Plant Accessories.....	2
6.3" UF Membrane Plant Accessories.....	3
8.0" RO Membrane Accessories.....	4
8.0" RO Membrane Housing Layout Options.....	5
Permeate Connection Hoses.....	6
Permeate Connection Recommended Installation.....	7
Seal Selection.....	8
Removal Tools.....	8
Ordering Information.....	9





### 3.8" RO Membrane Plant Accessories

	Part Number	Description
	38-L-0830-IC-PS	3.8" Gold polysulfone ATD with lip seal profile to suit 0.830" permeate tube
	38-L-0830-IC-ST06	3.8" Stainless Steel ATD with lip seal profile to suit 0.830" permeate tube. 6mm thick SS
	S-L-BEP	Small Blank End Plug with lip seal profile to suit 0.830" Permeate tube
	S-L-BEP-ST	Small Stainless Steel Blank End Plug with lip seal profile to suit 0.830" permeate tubes.
	S-L-EPDM	Small Lip Seal BLACK EPDM to suit 0.830" permeate tube
	S-L-VITON	Small Lip Seal ORANGE VITON to suit 0.830" permeate tube
	Permeate hoses	Permeate Connection Hoses come in a range of sizes, see table below for sizes

## 6.3" UF Membrane Plant Accessories

Part Number	Description
	<p>63-L-1138-IC-PS</p> <p>6.3" Gold polysulfone ATD with lip seal profile to suit 1.138" Permeate tube</p>
	<p>63-L-1138-IC-ST08</p> <p>6.3" Stainless Steel ATD with lip seal profile to suit 1.138" permeate tube. 8mm thick SS</p>
	<p>L-L-BEP</p> <p>Large Blank End Plug with lip seal profile to suit 1.125" and 1.138" permeate tubes</p>
	<p>L-L-BEP-ST</p> <p>Large Stainless Steel Blank End Plug with lip seal profile to suit 1.125" and 1.138" permeate tubes.</p>
	<p>L-L-VITON</p> <p>Large Lip Seal ORANGE VITON to suit 1.138" permeate tube</p>
	<p>Permeate hoses</p> <p>Permeate Connection Hoses come in a range of sizes, see table below for sizes</p>

## 8.0" RO Membrane Accessories

	Part Number	Description
	80-L-1125-IC-PS	8.0" Gold polysulfone ATD with lip seal profile to suit 1.125" Permeate tube
	80-L-1125-IC-ST08	8.0" Stainless Steel ATD with lip seal profile to suit 1.125" permeate tube. 8mm thick SS <b>INTERCONNECTING ATD</b>
	80-L-1125-IC-ST12-WM	8.0" Stainless Steel ATD with lip seal profile to suit 1.125" permeate tube. 12mm thick SS <b>END ATD</b>
	80-L-1125-IC-ST12-FM	8.0" Stainless Steel ATD with lip seal profile to suit 1.125" permeate tube. 12mm thick SS <b>END ATD</b>
	L-L-BEP	Large Blank End Plug with lip seal profile to suit 1.125" and 1.138" permeate tubes
	L-L-BEP-ST	Large Stainless Steel Blank End Plug with lip seal profile to suit 1.125" and 1.138" permeate tubes.
	L-L-EPDM	Large Lip Seal BLACK EPDM to suit 1.125" permeate tube
	Permeate hoses	Permeate Connection Hoses come in a range of sizes, see table below for sizes

# 8.0" RO Membrane Housing Layout Options

Polysulfone Layout Option

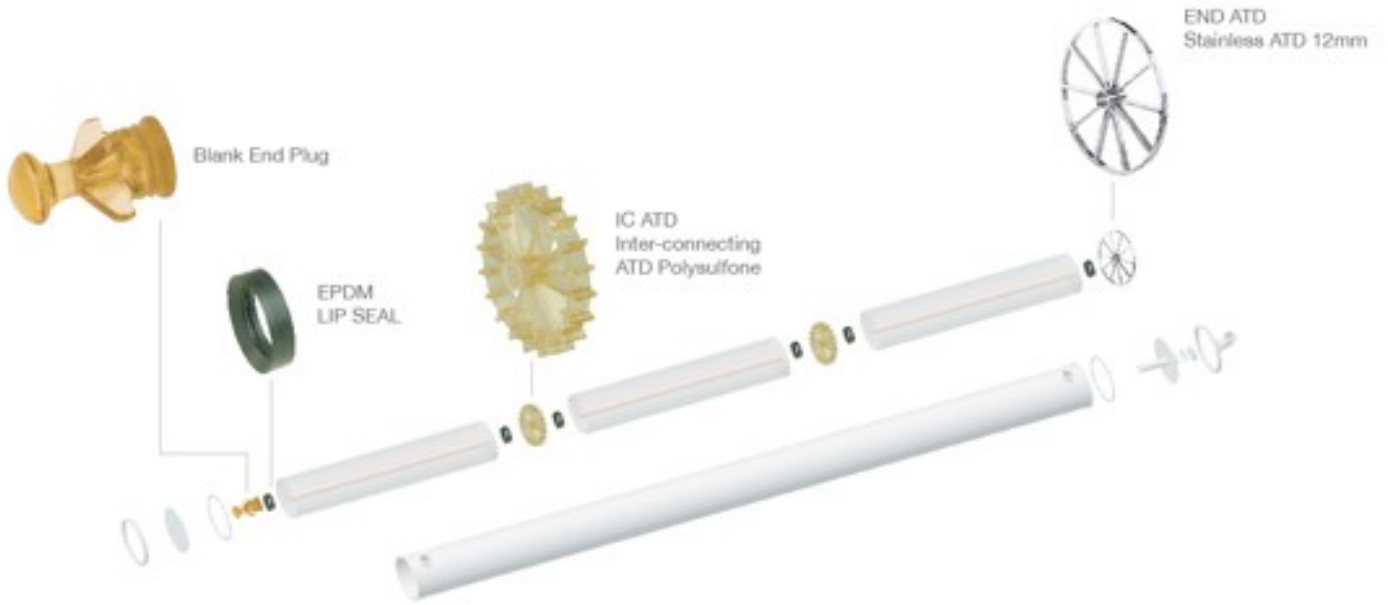

Stainless Layout Option

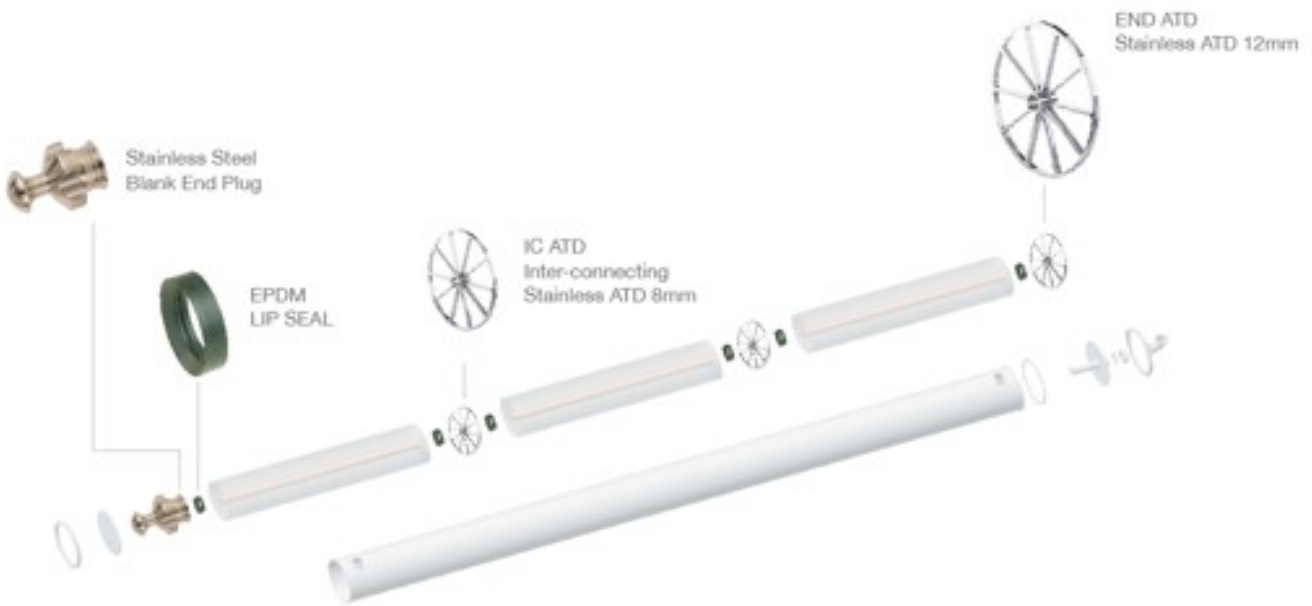

# Permeate Connection Hoses

Temperature range: -10°C + 60°C, Max Working Pressure 6 Bar, Max Bend Radius 130°

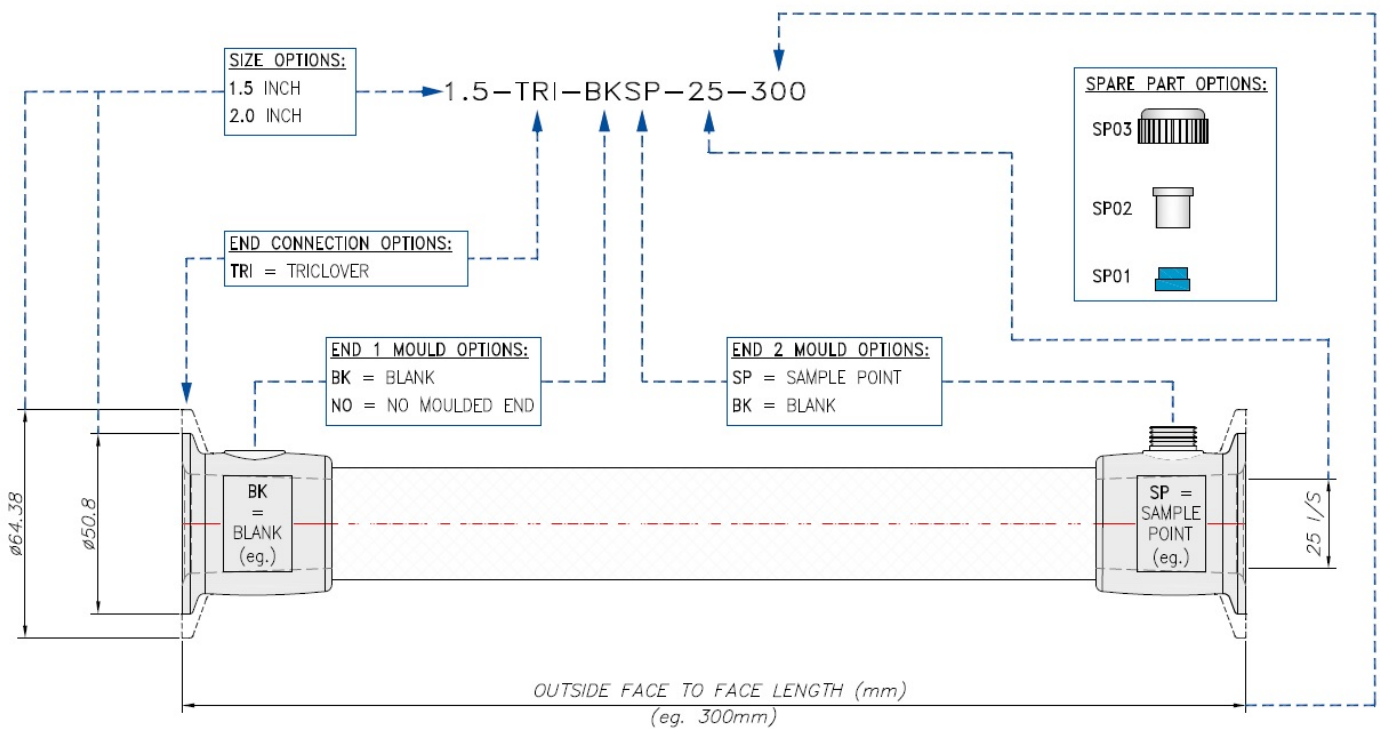

Product Description	Code
1.5" Tri-clover with Sample Point 25mm Dia hose 300mm long	1.5-TRI-BKSP-25-300
1.5" Tri-clover with Sample Point 25mm Dia hose 450mm long	1.5-TRI-BKSP-25-450
1.5" Tri-clover with NO Sample Point 19mm Dia hose 300mm long Limited Stock, end of product line	1.5-TRI-BKBK-19-300
2.0" Tri-clover with Sample Point 25mm Dia hose 300mm long	2.0-TRI-BKSP-25-300
2.0" Tri-clover with Sample Point 25mm Dia hose 450mm long	2.0-TRI-BKSP-25-450

# Permeate Connection Recommended Installation

Hose Type				
Hose No.	Angle	Total Length	Ferrule Size	Radius
A	45°	300mm	ø38/51 O/D	275mm
B	90°	300mm	ø38/51 O/D	138mm
C	45°	450mm	ø38/51 O/D	465mm
D	90°	450mm	ø38/51 O/D	233mm

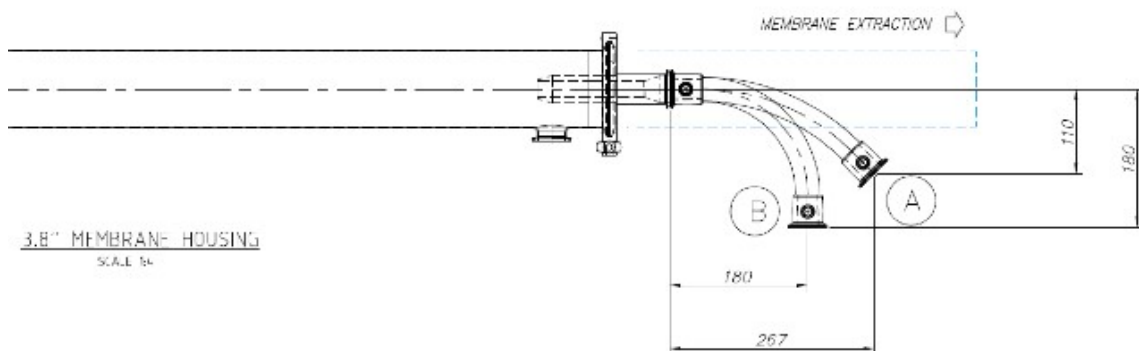
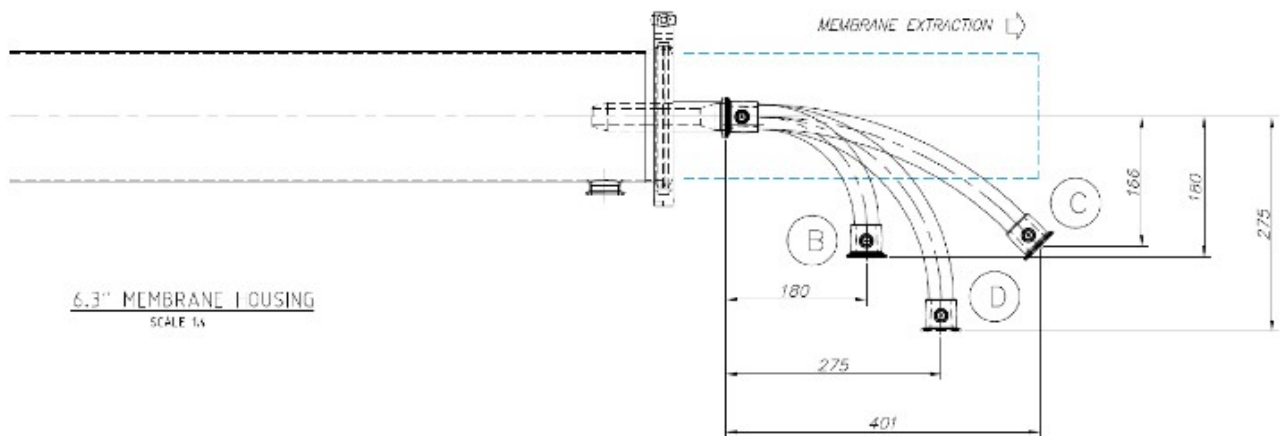
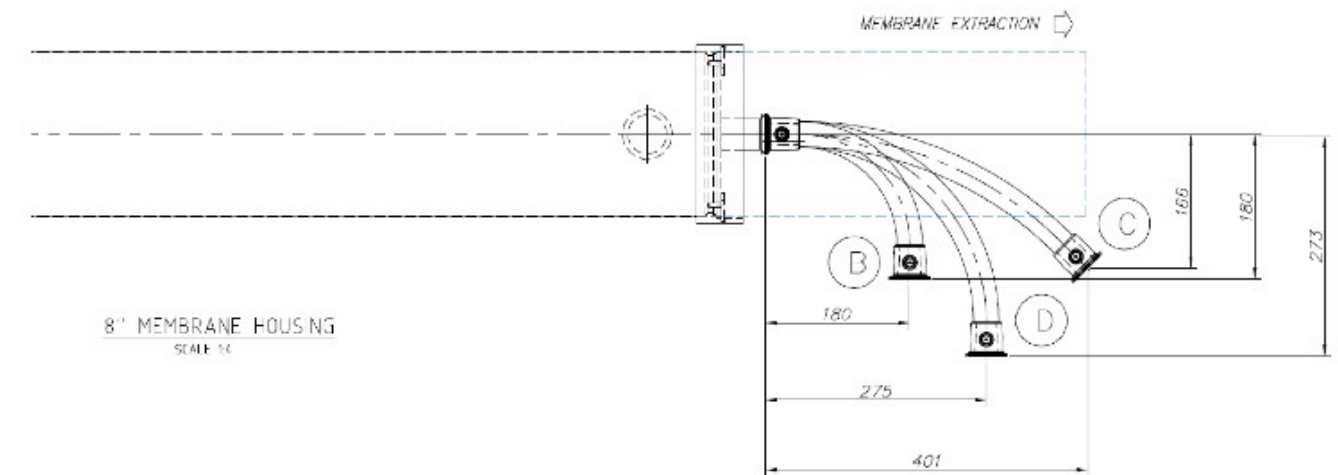

## Seal Selection

EPDM – perfect for non chlorinated systems, specifically RO and NF applications VITON- highly recommended for chlorinated environments, specifically UF applications.

## Removal Tools

	Part Number	Description
	MTK	<p>Complete Tool Kit</p> <ul style="list-style-type: none"><li>• Housing End Cap Removal Tools</li><li>• Removal of Membranes from the Housing<ul style="list-style-type: none"><li>• Membrane Push Rod Tool</li></ul></li><li>• Membrane Ejector Block Pigging Tools</li><li>• Removal of ATD's and Blank End Plugs from the Membranes</li></ul>
	MEK-SPATULA	ATD Removal Spatula Tool
	BEPREMOVAL	Blank End Plug Removal Tool



## Ordering Information

Smart Membrane Solutions,

1. This Smart Membrane Solutions price list supersedes all other price lists.
2. Prices are Ex-store, NZ.
3. Prices are subject to change without notice.
4. All prices in New Zealand Dollars (\$NZ).

Orders,

A company Purchase Order must be received before product is dispatched.

Please send Purchase Order by email to: [orders@smartmembranesolutions.co.nz](mailto:orders@smartmembranesolutions.co.nz)

For all Smart Membrane Solutions customer service and ordering please make sure that your records list the following information:

Smart Membrane Solutions  
PO Box 148  
Rolleston 7643

Telephone           +64 3 741 1808

Visit our web site at [www.smartmembranesolutions.co.nz](http://www.smartmembranesolutions.co.nz) for detailed product information and specifications.